

PRODUCT INFORMATION

V6 DF250T/225T



THE
ULTIMATE
4-STROKE OUTBOARD



Way of Life!

SUZUKI'S AWARD WINNING TECHNOLOGY

The product of unrivaled expertise and world class technology, Suzuki's four-stroke outboards have long been on the cutting edge of outboard performance winning acclaim and awards for their advanced technology, innovative ideas, and designs.

We were the first to introduce a digital Electronic Fuel Injection four-stroke; an idea that allowed the DF70 and DF60 to receive further recognition from the International Marine Trades Exposition and Convention when they captured the IMTEC Innovation Award. We were the first to offer an automotive type self-adjusting timing chain in a four-stroke engine with performance-enhancing dual overhead cams and four valves per cylinder. This brought us recognition again, when our DF50 and DF40 received the IMTEC Innovation Award making Suzuki the first manufacturer to receive this distinguished award two years in a row, and also giving us our third IMTEC award, again an industry first.

DF140 and DF115/90 were the first to offer an offset driveshaft with a two-stage cam drive system and two-stage gear reduction system, making them the most compact outboards in their class.

At its first showing at a special preview at the 2003 Miami International Boat Show, the DF250T captured the NMMA (National Marine Manufacturers Association) 2003 Innovation Award making this the fourth Innovation Award for Suzuki.



DF250T

Innovative Compact High Performance Engine Delivers the Ultimate in Power and Performance

The engine was designed from the ground up, specifically for outboard use, by Suzuki engineers who drew on decades of knowledge gained through the manufacture of not only outboards, but also technologically-advanced motorcycles and automobiles. The product of their labors was an all-new 3.6-liter DOHC, 24-valve V6 engine that held some of our most advanced and innovative ideas to date. For the US market, we created two configurations, each of which is designed to deliver the ultimate in power and performance.

The DF250T was the marine industry's first V6 250 HP four-stroke outboard and Suzuki's most powerful outboard built to date. With 3.6 liter displacement and producing 69 HP per liter, it held the greatest power to displacement ratio and the greatest power to weight ratio the industry had ever seen in the four-stroke category.

Delivering 225 HP, the DF225T provides the largest displacement in its respective category while its narrow profile makes it, like the DF250T, one of the lightest and most compact outboards in their class.



THE DF250 – THE ULTIMATE IN PERFORMANCE

DOHC 24-Valve with VVT Delivers High Performance

Our engineers designed a 3.6-liter V6 engine – the largest displacement found in the industry at the time – and an aggressive cam profile designed specifically for the DF250T to create the industry’s first V6 250 horsepower four-stroke outboard.

However, our goal was not just to create an outboard that could deliver 250HP, but to create an outboard that could deliver high performance that suits its 250HP output along with the many other benefits that a four-stroke can deliver.

A high performance camshaft designed to deliver 250 horsepower produced the wanted power output, but to get the strong mid and low-end torque outboards need when accelerating requires altering valve timing. In general, only using a camshaft setting like those found in racing engines produces an engine that develops sufficient low and mid range torque. This is because the valve timing for intake and exhaust differs according to load and engine speed.

The common idea is that the intake valve opens after the exhaust valve is fully closed however, the intake valve actually starts opening before the exhaust valve fully closes, creating a momentary overlap in the timing where both valves are open.

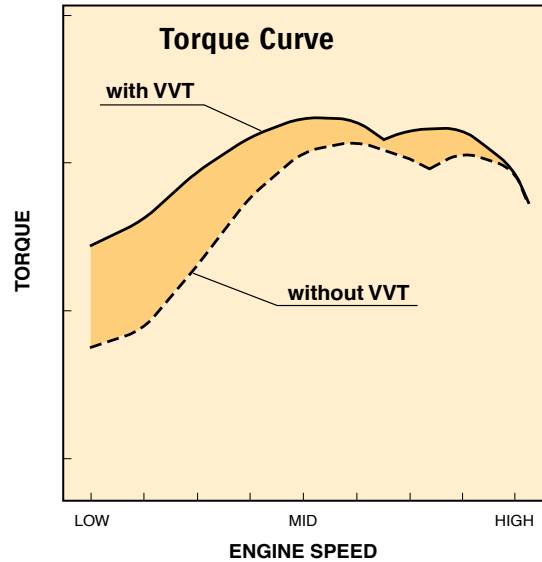

* At the comparison test, Multi-Stage Induction System of the motor was operated.

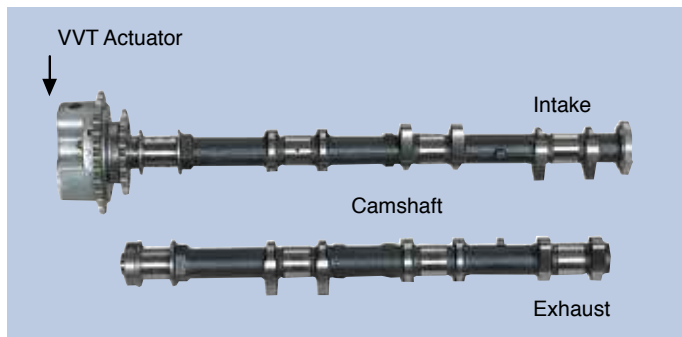
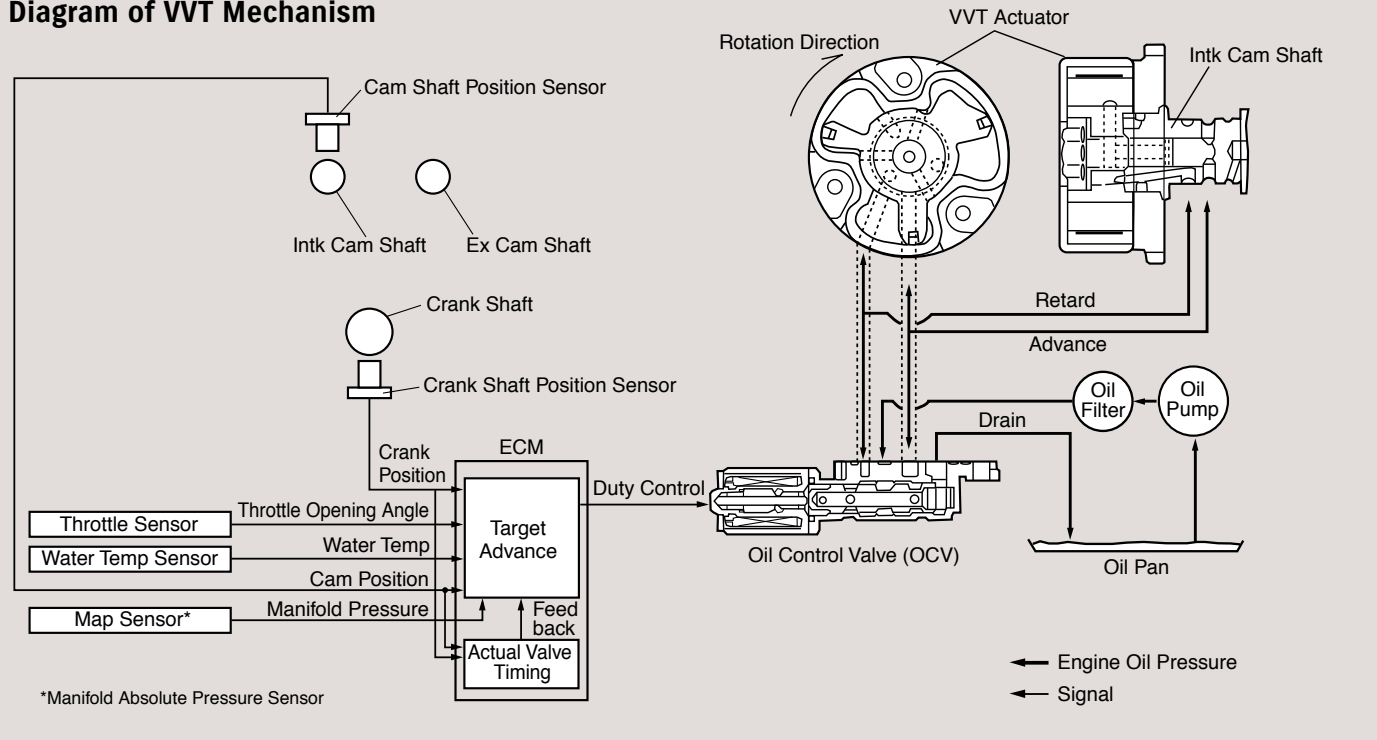

Diagram of VVT Mechanism



*Manifold Absolute Pressure Sensor

Using VVT (Variable Valve Timing) in the DF250T, this overlap can be increased or decreased by altering intake timing with the camshaft, thereby optimizing camshaft timing for low range and mid range operation. As the DF250T's camshaft is already setup to deliver maximum output at high rpm, a change in timing in this range is mostly unnecessary. Increasing the overlap is necessary during acceleration in the low and mid power range, but no change in timing is required for stable idling.

In the DF250T's VVT system there are two chambers within the VVT actuator, one on the phase angle forward side and another on the phase angle backward side, to which hydraulic pressure is continuously applied to change the valve timing of the intake cam. When the engine is stopped, idling or other times that there is no oil pressure in the system, the VVT actuator locks, disengaging the system.

Graph Illustrating the Variance in Valve Lift Using VVT

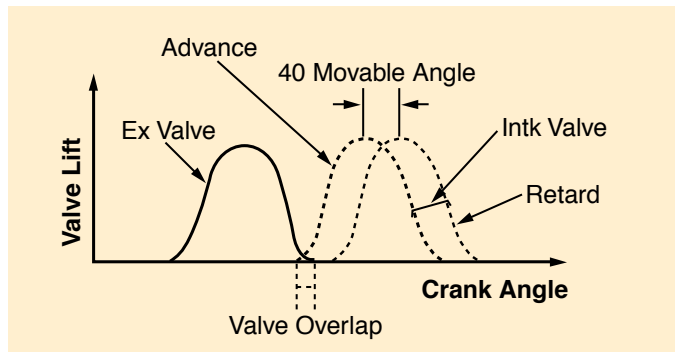

Multi-Stage Induction (DF250/DF225)

The DF250 and DF225 utilize multi-stage induction to enhance engine performance by changing the length of intake manifold pipes according to engine speed. The system utilizes two intake manifold pipes per cylinder, one operating at low engine speed and another operating at high. When the engine is operating at lower rpm, air enters the combustion chamber through the longer, curved manifold pipe. The pipe's length is designed to allow an optimum volume of fresh air into the chamber to improve combustion and boost low-end torque.

As rpm pass a preset threshold, the valve on the direct intake pipe opens up letting air enter directly into the combustion chamber. Short, straight and lacking resistance it gets a greater volume of air into the chamber, increasing the engine's ability to breathe at high rpm, thus improving high speed power output.

The engine cover is designed with a large air intake, which extends both sides to provide maximum airflow into the cowling.



Air Flow in Multi-Stage Induction Module

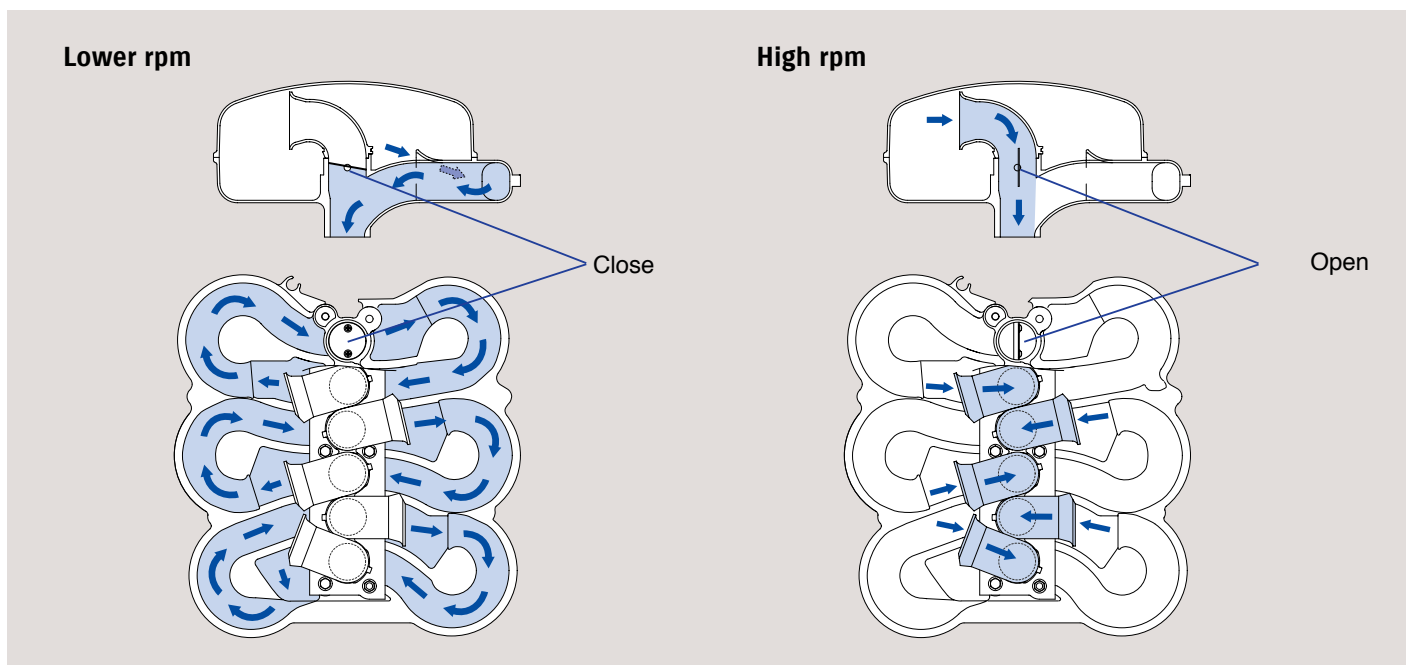

Two-Stage Gear Reduction

With such a high performance engine now at our disposal, losing any power in the propulsion system would be a waste, so our engineers chose an efficient means of supplying maximum propulsion. A propeller rotating at high speed in the water has a tendency to slip and when two propellers of the same pitch but different diameters are rotated, the smaller propeller will slip more than the larger. So to obtain maximum propulsion, spinning a larger diameter propeller with a suitable pitch is the answer.

But to spin a larger propeller, more torque in the propeller shaft becomes necessary. In order to obtain the required amount of torque however, the corresponding increases in weight and resistance due to the use of larger gears and a larger gearbox do not always provide effective results. The answer to this dilemma is found in the use of a two-stage gear reduction system that provides the necessary torque without adding unwanted bulk and weight.

Propeller Diameter Comparison

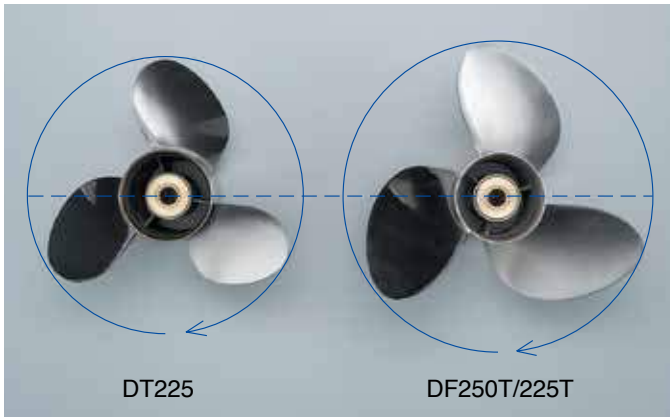

The DF250 and DF225 utilize a first stage gear reduction (32:40) between the crankshaft and driveshaft, and a second stage reduction (12:22) in the lower unit's gear case, resulting in an overall gear ratio of 2.29. This is the largest gear reduction ratio found in any outboard over 200PS (147kW) two-strokes included. Such a powerful reduction allows these outboards to turn a 16-inch diameter propeller, which, while being larger than the 14-1/2-inch diameter propeller found on the two-stroke DT225, is also larger than those previously used on a V6 outboards. For this reason, both outboards are equipped with a propeller specially designed for greater acceleration and maximum speed.

Along with greater acceleration, the gear reduction in combination with the four-stroke engine's wide power band is capable of handling a wide variety of loads, which is a significant benefit to boaters whose loads vary from day to day.

Compact Designs

55-Degree Bank Angle Creates a Compact V6

With the DF250 and DF225, one major design objective our engineers set out to realize was to design and produce a compact, narrow profile motor. This was met by abandoning the 60-degree bank angle normally utilized in V-type blocks and designing an all-new V-design block using a 55-degree bank angle—an industry first. When compared to the industry norm of 60-degrees, as shown in the engine cover comparison, the difference in size becomes quite clear.

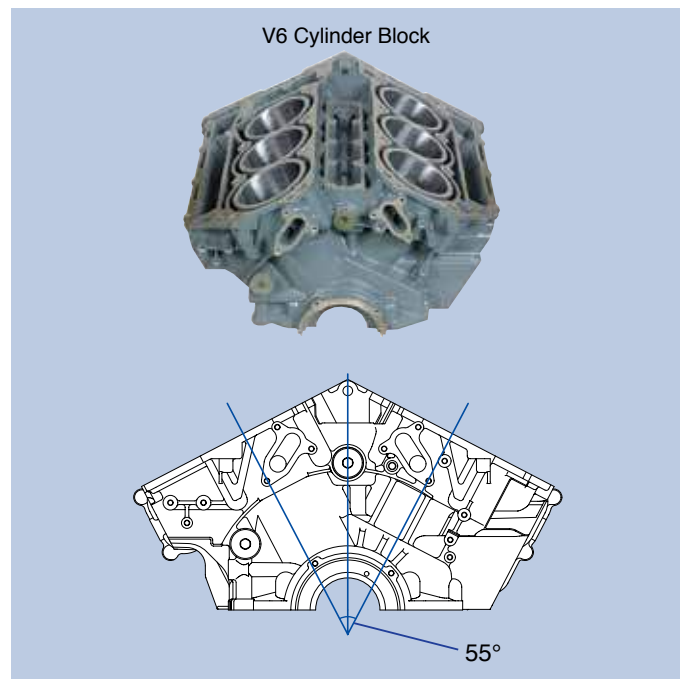

Engine Cover Profile Comparison

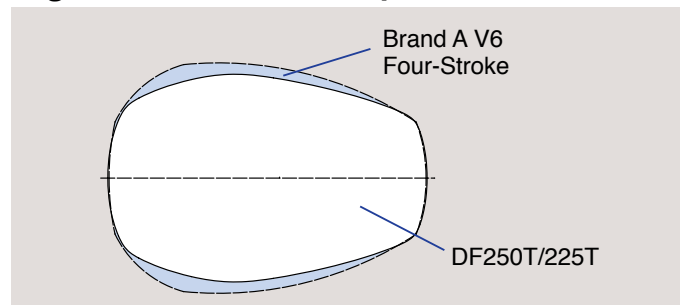

Offset Driveshaft

Suzuki's utilization of an offset driveshaft in the DF140, 115 and 90 proved to be successful in reducing the size of the outboard. The DF250T and DF225T benefit from this same design which positions the crankshaft in front of the drive shaft, simultaneously moving the outboard's center of gravity forward. This system adds to the compactness of the outboard and provides an improvement in power performance. It also places the engine's axis of inertia, the point where vibrations produced by the engine are at a minimum, up over the upper engine mount thus greatly reducing vibration.

Offset Drive Shaft

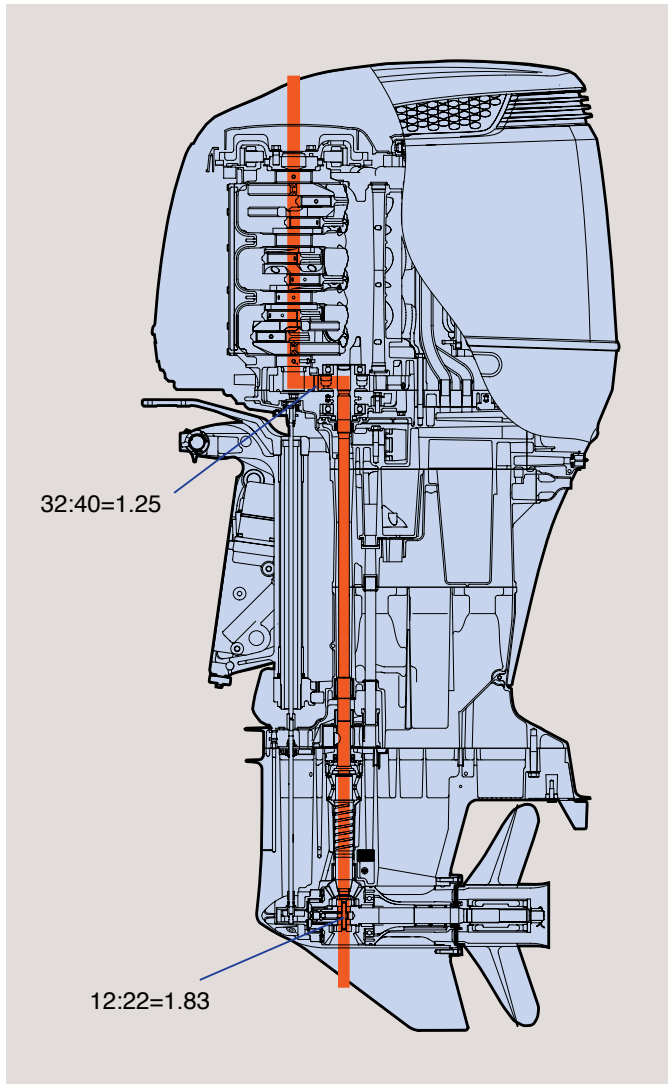

Two-Stage Cam Drive System

The two-stage cam drive system utilized in the DF250T and DF225T incorporate both gears and a chain. The system's first stage gears transfer power between the crankshaft and the drive shaft (32:40) while the second stage utilizes a chain to deliver power from the drive shaft to the camshaft (20:32). This allows for the use of smaller diameter cam sprockets, which in turn allows for a reduction in valve angles also reducing the size of the cylinder head. The timing chain is equipped with an automatic hydraulic tensioner to keep the chain properly tensioned. This system provides years of maintenance-free operation.

Cam Drive System

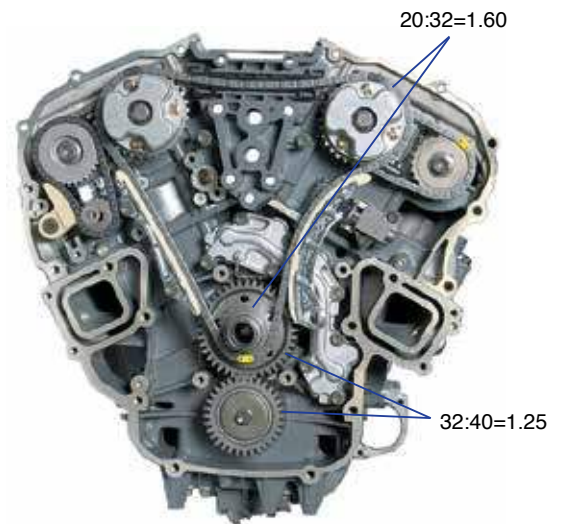

Direct Ignition

An advanced direct ignition system used in both of these V6 outboards utilizes integral type spark plug caps with ignition coils. While reducing the number of parts and simplifying the wiring system, this arrangement also greatly reduces electronic engine "noise" that can interfere with VHF radios, fish finders and other marine electronics. Controlled by the outboard's powerful 32-bit computer this system provides each cylinder with optimum spark strength and timing.



Multi Point Electronic Fuel Injection

As Suzuki was the first in the industry to incorporate multi point electronic fuel injection in a four-stroke outboard with the DF70 and DF60, it is only natural that the DF250T and DF225T would incorporate the same. Along with Suzuki's Multi Point Sequential Fuel Injection, both outboards incorporate an ECM (Engine Control Module) which constantly monitors crucial data, in real time, from a series of sensors placed in critical areas on the engine. This comprehensive network of sensors includes the Manifold Absolute Pressure Sensor, Crankshaft Position Sensor, Intake Air Temperature Sensor, Cylinder Wall Temperature Sensor, Camshaft Position Sensor and Exhaust Jacket Temperature Sensor. To process all of this data efficiently, the ECM relies on a very powerful 32-bit computer which instantly calculates the optimum amount of fuel to be injected at high pressure

into each of the cylinders by the Multi Point Sequential Fuel Injection system. This system greatly reduces exhaust emissions allowing all three outboards to pass both the EPA 2006 regulations and CARB 2008 regulations, the strictest exhaust regulations to date, while providing lower fuel consumption, smooth starts, crisp acceleration, smooth performance and maximum efficiency.

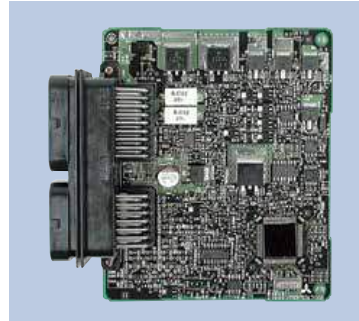

Electronic Control Module (ECM)

Multi Point Sequential Electronic Fuel Injection (DF250)

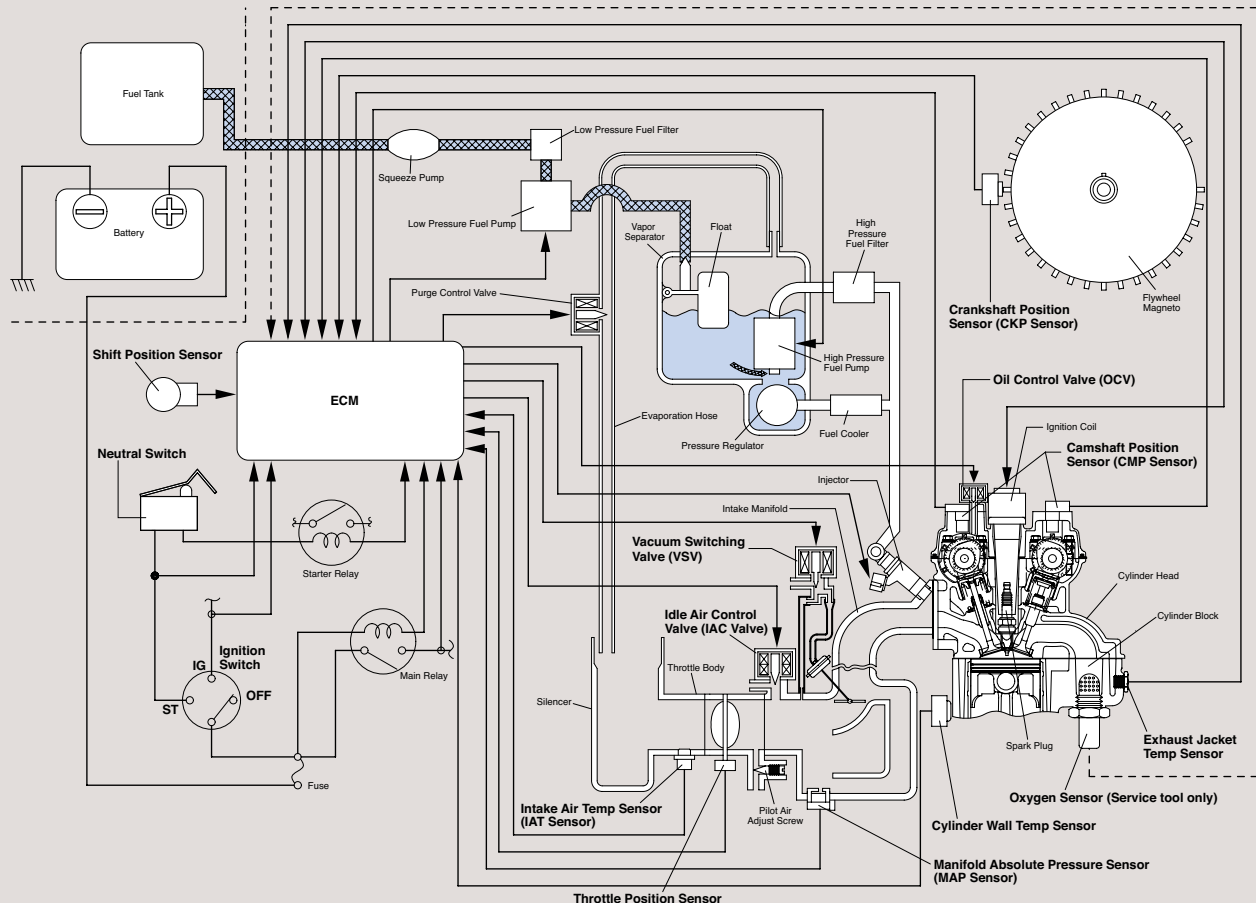

■ Durability and Reliability

Keeping The Engine and Components Cool

Fitted with fan blades the flywheel serves a dual purpose by efficiently expelling heat from within the engine cover out of the side of the cowl, keeping the temperature within the cowl under control.

Water circulating around the oil jacket located at the base of the V-bank cools oil flowing through the pipe, keeping oil temperature under control. This contributes to the cooling of the engine thereby enhancing durability.

Both outboards also utilize piston cooling jets which shoot a stream of oil onto the backside of the pistons to aid in cooling. Fine nozzles deliver a well-defined stream of oil that is precise and accurate. The engines are also equipped with another cooling jet that shoots a stream of oil onto the main cam chain and drive gear to keep those components cool and lubricated as well.

Suzuki Anti-Corrosion Finish

Suzuki has formulated an anti-corrosion finish that both increases the durability of the engine and protects those parts of the aluminum exterior that are constantly exposed to saltwater. The Suzuki Anti-Corrosion Finish is a specially formulated advanced finish that offers maximum bonding of the finish to the aluminum surface for an effective treatment against corrosion.

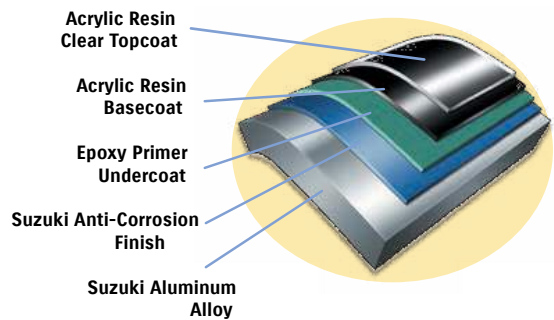

CARB 3 Stars

The DF250T and DF225T have received the CARB 3-Star rating, which identifies engines that meet the California Air Resources Board's 2008 exhaust emission standards. The strictest exhaust regulations to date, they represent a 65% reduction in emissions from the EPA 2006 emission standards.



High Output Alternator

The outboards are also equipped with a high output alternator that delivers a total 54 A (12V) of electrical power. Designed to produce a majority of this power at low rpm, it generates around 38 A even at a low 1,000 rpm—a generous amount of current to keep an assortment of electronics up and running.

Tilt Limit Switch

The motor tilt system incorporates a user settable tilt limit switch, which prevents the motor from tilting beyond a predetermined position. This can be used to protect both the boat and motor from damage that can occur when tilting the motor.

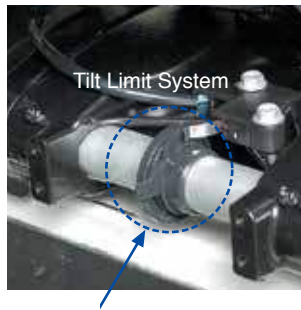

Fuel Filter

The fuel system is equipped with a large and easy to maintain fuel filter which removes contaminants from the fuel before they reach the engine to protect the engine from damage.

Convenient Function

Lower cover separates into two sections to allow easier access for maintenance to the V6 engine.

An oil change reminder system, built into the Multi-Function Tachometer (Optional), informs the user with a flashing oil lamp when it is time to change the oil.

Oil changes are easy with the oil drain plug located on the front of the oil pan, the oil filler cap on the top of the cylinder head, and a spin-on oil filter.

A comprehensive monitoring system built into the Multi-Function Tachometer (Optional) detects abnormalities in the running of the outboard to provide information and alerts so that appropriate measures can be taken before the problem becomes serious.

MODEL	SHAFT	ROTATION	COLOR
DF225TX2	25"	STANDARD	BLACK
DF225TXW2	25"	STANDARD	WHITE
DF225TXZW2	25"	COUNTER	WHITE
DF250TX2	25"	STANDARD	BLACK
DF250TXW2	25"	STANDARD	WHITE
DF250TXZ2	25"	COUNTER	BLACK
DF250TXZW2	25"	COUNTER	WHITE
DF250TXX2	30"	STANDARD	BLACK
DF250TXXW2	30"	STANDARD	WHITE
DF250TXXZ2	30"	COUNTER	BLACK
DF250TXXZW2	30"	COUNTER	WHITE



The DF250T and DF225T are available in your choice of Pearl Nebular Black or Cool White

DF250T/225T SPECIFICATIONS

MODEL	DF250T/225T
RECOMMENDED TRANSOM HEIGHT IN	X: 25 XX: 30 (250T Only)
STARTING SYSTEM	Electric
WEIGHT LBS *	X: 606 XX: 626
ENGINE TYPE	DOHC 24-Valve
FUEL DELIVERY SYSTEM	Multi-Point Sequential EFI
NO. OF CYLINDERS	V6 (55-degree)
PISTON DISPLACEMENT IN ³	220.5
BORE X STROKE IN	3.75 x 3.35
MAXIMUM OUTPUT HP (PS)	DF225T: 225 DF250T: 250
FULL THROTTLE OPERATING RANGE RPM	DF225: 5,000-6,000 DF250: 5,500-6,100
STEERING	Remote
OIL PAN CAPACITY QT	8.5
IGNITION SYSTEM	Fully-transistorized
ALTERNATOR	12V 54A
ENGINE MOUNTING	Shear Mount
TRIM METHOD	Power Trim and Tilt
GEAR RATIO	2.29:1
GEAR SHIFT	F-N-R
EXHAUST	Through Prop Hub Exhaust
PROPELLER SELECTION (PITCH)**	17"-28"

DIMENSIONS

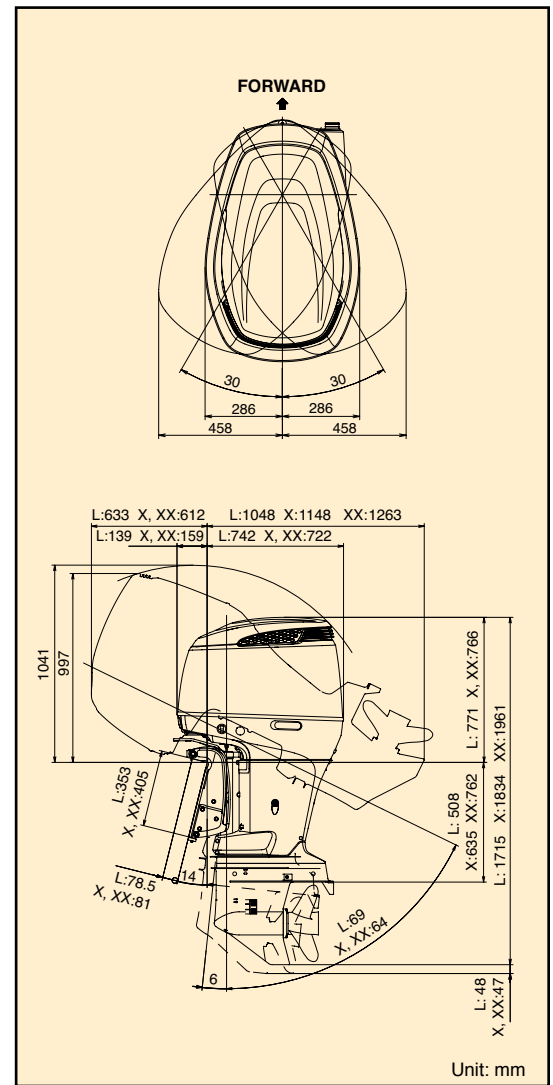

* Dry weight, including battery cable, not including propeller and engine oil.

**Boats and motors come in a large variety of combinations. See your authorized dealer for correct prop. selection to meet recommended RPM range at W.O.T. Please read your owners manual carefully. Remember, boating and alcohol or other drugs don't mix. Please operate your outboard safely and responsibly. Suzuki encourages you to operate your boat safely and with respect for the marine environment.

SUZUKI MOTOR CORPORATION reserves the right to change, without notice, equipment, specifications, colors, materials and other items to apply to local conditions. Each model may be discontinued without notice. Please inquire at your local dealer for details of any such changes. Actual body colors may differ slightly from the colors in this brochure.

DF250T/225T FEATURES

- V-design Engine Block using a 55-degree Bank Angle
- DOHC 24-valve Engine
- Variable Valve Timing System (DF250)
- Multi-Stage Induction (DF250/DF225)
- Multi Point Sequential Electronic Fuel Injection
- Direct Ignition
- Offset Driveshaft
- Two-stage Gear Reduction
- Two-stage Camshaft Drive System
- Flywheel Designed with Fan Blades
- 54A Alternator
- Counter Rotation Models Available
- Tilt Limit Switch
- Oil Change Reminder System
- Low Oil Pressure Caution
- Over-Rev Limiter
- Overheat Cooling Water Caution
- Self Diagnostic System
- Neutral rpm Limiter
- Anti-Corrosion Protection
- Two Freshwater Flushing Ports
- High Performance 16-in. Diameter Stainless Steel Propeller (Optional)
- Multi Function Tachometer (Optional)



CARB Three-Star Label
The three-star label identifies engines that meet the California Air Resources Board's 2008 exhaust emission standards. Engines meeting these standards have 65% lower emissions than EPA 2006 exhaust emission standards.



EPA 2006 Label
Suzuki's four-stroke technology ensure compliance with EPA 2006 exhaust emission standards set by the U.S. Environmental Protection Agency.



www.suzukimarine.com

Part No. 99953-22550-019
Printed in USA